

DIESEL GENERATING SET



Model	SP-200P	
Standby	kVA	220
	kW	176
Prime	kVA	200
	kW	160
Rated Voltage	V	220 / 380
Phase		3
Rated Current	A	304
Rated Rotation Speed	r/min	1500
Frequency	Hz	50
Power Factor		0.8
Noise Level	dB(A)@7m	Silent Type : ±70

Standby: Continuous running at variable load for duration of an emergency. No overload is permitted on these ratings. In accordance with ISO 3046.
 Prime : Continuous running at variable load for unlimited periods with 10% overload available for 1 hour in any 12 hour period. In accordance with ISO 8528,ISO 3046.



ENGINE

Manufacturer	PERKINS
Model	1106A-70TAG4
Engine speed rated	1500 RPM
Cycle	Four Stroke
No. Cylinders and Build	6 vertical in-line
Displacement	7.01 L
Bore and Stroke	105 mm x 135 mm
Compression ratio	16:1
Governor	Mechanical
Aspiration	Turbocharged aftercooled
Fuel consumption 110%	49.4 L/hr
Fuel consumption 100% (of the Prime Power)	45.8 L/hr
Fuel consumption 75% (of the Prime Power)	34.7 L/hr
Fuel consumption 50% (of the Prime Power)	23.1 L/hr
Fuel Tank Capacity	300 L
Lubrication Capacity	16.5 L
Coolant Capacity	21 L
Starting Voltage	12 Volt DC

ALTERNATOR

Manufacturer	GENSO
Number of phase power	3
Factor (Cos Phi)	0.8
Bearing	1
Exciter type	Brushless, Self-excitation
Insulation : class, temperature rise	H
Degree of protection	IP23
Winding Pitch	2/3
Winding Leads	12

CONTROL SYSTEM

The control panel is equipped as follows:

1. Auto Mains Failure Control Panel

Panel equipments:

- Control with AMF module
- Static battery charger
- Emergency stop push button



DSE 6120

Generating set control module DSE 6120 features:

- The module is used to monitor main supply and starts and stops of a standby generating set
- Micro-processor based design,
- Automatic control of main and generator contactors
- Monitors engine performance and AC power output
- LED alarm indication
- Front panel configuration of timers and alarm trip points
- Easy push button control
STOP/RESET - MANUAL - TEST - AUTO - MUTE ALARM -START
- Generator Volts (L-L / L-N)
- Engine oil pressure (PSI-Bar)
- Generator Ampere (L1,L2,L3)
- Engine temperature (°C&°F)
- Generator Frequency (Hz)
- Plant battery volts
- Engine hours run
- Mains Volts (Ph-Ph/Ph-N)
- Generator kVA, kWh
- Generator kW as % of rated kW setting
- Generator Cos (σ)

Protecting Functions:

- Over and Under Speed
- Low and High Battery Volt
- Start and Stop Failure
- Charge fail
- Over Current
- Under / Over Generator Voltage
- Low Oil Pressure
- Emergency stop
- High engine temperature
- Kw overload

LED indications

- Mains available
- Generator available
- Mains on load
- Generator on load

2. Power Outlet Terminal Board Mounted on the Gen-set Base Frame

GENSET OUTLINE

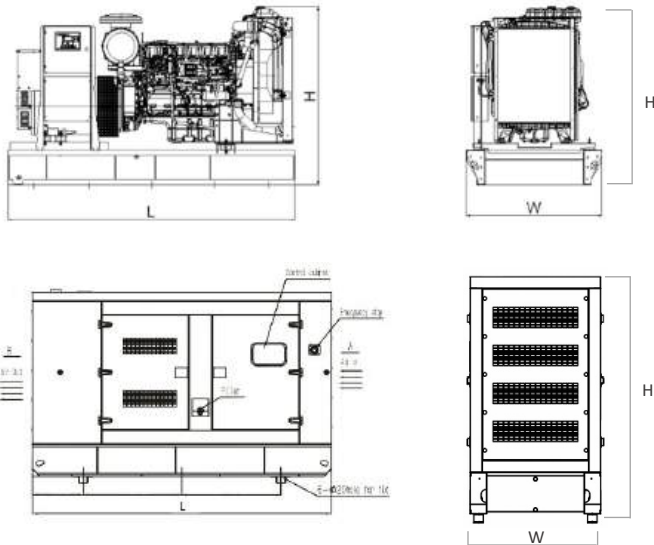

Dimension & Weight :

OPEN TYPE	
Length (L)	2450 mm
Width (W)	860 mm
Height (H)	1550 mm
Weight	2400 kg

SILENT TYPE	
Length (L)	3410 mm
Width (W)	1200 mm
Height (H)	1500 mm
Weight	2800 kg

ADVANTAGES

- Compact design
- Easy operation and maintenance, low cost
- Every generating set is subject to a comprehensive test program which includes full load testing, checking and provision of all control and safety shut down functions testing

CHASSIS

- The complete gen-set is mounted as whole on a heavy-duty fabricated, steel base frame
- High quality base frame complete with heavy duty engine mounting for reduce vibration
- Base frame design integrated with fuel tank (up to 650 KVA)
- The generating set can be lifted or carefully pushed / pulled by the base frame
- Dial type fuel gauge and drain plug on the fuel tank

CANOPY

- Doors on each side
- High quality paints materials
- High quality sound proof and insulations materials could efficiently reduce noise
- Easy lifting and moving
- Emergency stop push button is installed outside of the canopy
- Exhaust silencer is protected against environment influences